

905nm 10mw~20mw SM Coaxial Pigtailed Laser Diode with SMF

905nm~915nm SM Fiber Coupled LD with Single Mode Fiber (SM Fiber)

WSLP-905-015m-4-PD

Wavespectrum Laser Group

www.wavespectrum-laser.com

905nm Pigtailed Diode Laser		15mW/SM Fiber		Wavespectrum Laser, Inc	
PARAMETER	SYMBOL	VALUE	UNIT		
Reverse Voltage	V_r	2.0	V		
Operating Temperature	T_{op}	-20 ~ +50	°C		
Storage Temperature	T_{stg}	-40 ~ +85	°C		
Lead soldering temperature (5 sec.)	T_{is}	250	°C		
Features: <ul style="list-style-type: none"> • 905nm • SM Fiber • Coaxial package • Built-in PD 					
Applications: <ul style="list-style-type: none"> • Medical laser treatment • Sensor • Others 					
Specifications	WSLP-905-015m-4-PD				
	Min	Type	Max		
Center Wavelength@25°C	900nm	905nm	915nm		
Recommend Operating Temperature	25°C				
Output Power	----	15mw	----		
Fiber Type	Single Mode Fiber				
Fiber Core	5um				
Monitor Current	----	0.2mA	0.6mA		
PD Reverse Voltage	----	30V	----		
Fiber Connector	FC				
Fiber Length	----	80cm	100cm		
Threshold Current (Typ.)	----	30mA	50mA		
Operating Current (Typ.)	----	140mA	170mA		
Operating Voltage	----	1.9V	2.3V		
Package Style	Coaxial				
Photodiodes	Built-in				



Coaxial Package View

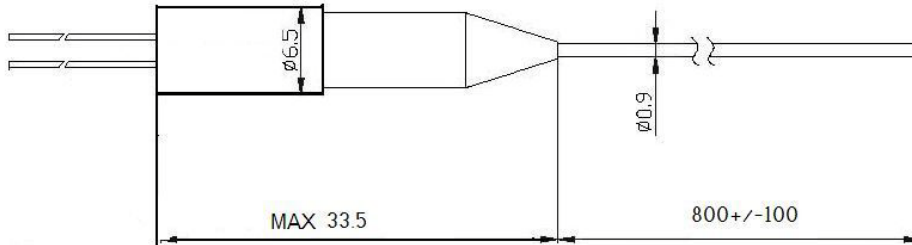

PIN Bottom View:

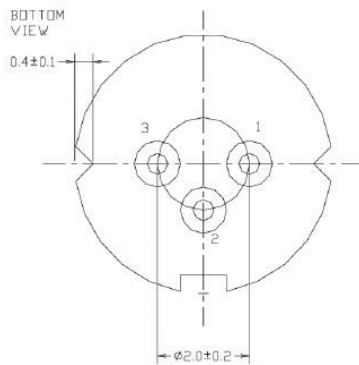

1	LD(-)
2	LD(+)&PD(-)
3	PD(+)

Electrically shorten LD module and store in non-extreme conditions.
Suggest using the constant current power supply.



Wavespectrum Laser, Inc.
www.wavespectrum-laser.com
wavespectrumlaser@gmail.com

