

830nm Collimated Laser Diode Module | Single Mode LD| 100mw Output Power| Collimation Beam
830nm IR LD| Small Compact Package| Built-in PD| Built-in TEC Cooling Optional
WSLM-830-100m-K
Wavespectrum Laser, Inc.
www.wavespectrum-laser.com

830nm Collimated Laser Diode 100mw		Wavespectrum Laser, Inc	
PARAMETER	SYMBOL	VALUE	UNIT
Reverse Voltage	V_r	2.0	V
Operating Temperature	T_{op}	-10 ~ +60	°C
Storage Temperature	T_{stg}	-40 ~ +80	°C
Lead soldering temperature (10 sec.)	T_{is}	260	°C
Features: <ul style="list-style-type: none"> ● 830nm ● Collimated Laser Beam ● Small Compact Package ● Excellent Beam Quality ● Built-in PD ● Built-in TEC Cooling Optional 			
Specifications		WSLM-830-100m-K	
		Min	Type
Center Wavelength@25°C		820nm	830nm
Output Power (CW Mode)		100mw	
Spatial Mode		Single Mode	
Lens Type		Aspheric Lens (with AR Coating)	
Beam Shape		Elliptical	
Beam Diameter @ Aperture		----	3mm _L x 1.5mm _{//}
Beam Divergence (Full Angle)		----	1mrad
Recommend Operating Temperature		25 °C	
Monitor Current		----	0.3mA
Threshold Current (Typ.)		----	40mA
Operating Current (Typ.)		----	120mA
Operating Voltage		----	2.3V
Housing Material		Aluminum	
Housing Dimensions		Customized	

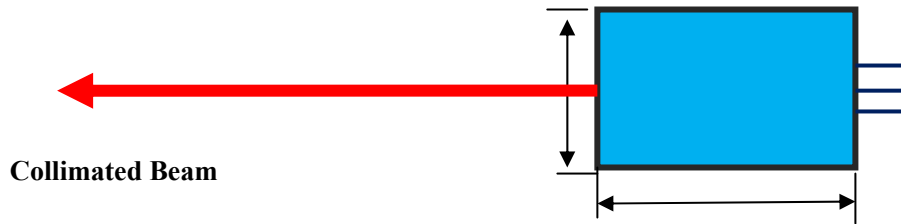

Drawing



PIN Bottom View:

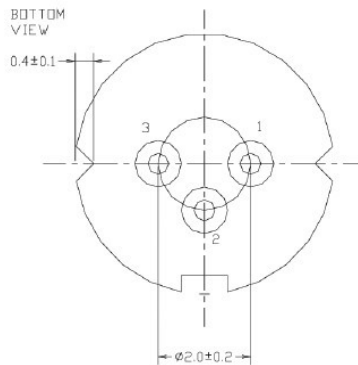

1	LD(-)
2	LD(+)&PD(-)
3	PD(+)

Electrically shorten LD module and store in non-extreme conditions.
 Suggest using the constant current power supply.

